

4

3

2

1

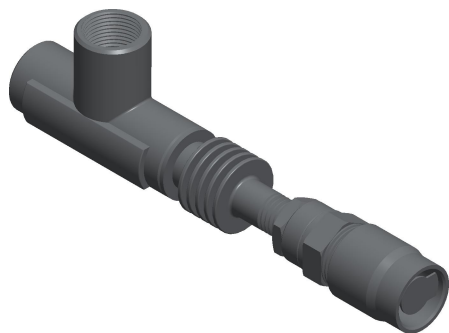

ITEM	DESCRIPTION	MATERIAL
1	VALVE BODY	CF8M (316 SS)
2	YOKE	300 Series SS
3	ADAPTER	300 Series SS
4	BUSHING SEALS	See Note #3
5	3/4" NPT BUSHING	300 Series SS
6	THERMAL ACTUATOR	300 Series SS
7	OPTIONAL BAND-O-LET FITTING	300 Series SS
8	LOCK NUT	300 Series SS

B

B

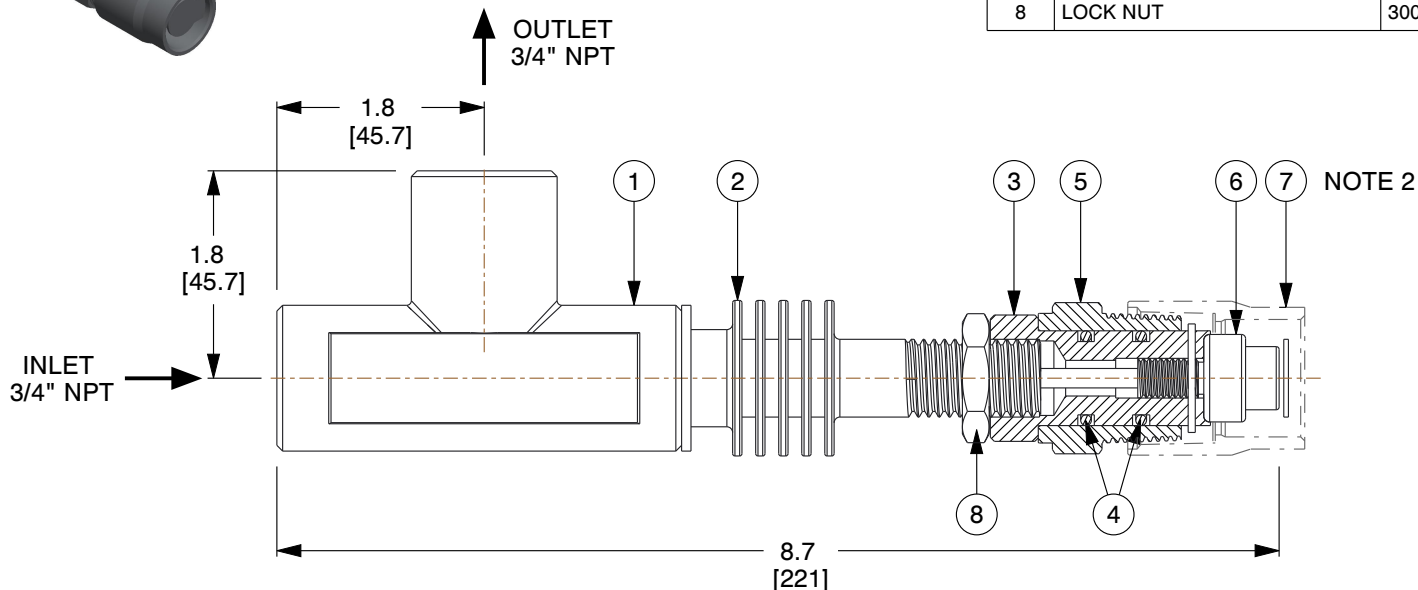
**NOTES:**

- FULL OPEN TEMPERATURE "XXX" AVAILABLE:
 - XR SERIES: 040°F, 045°F, 050°F, 060°F, 070°F, 075°F, 085°F, 095°F, 100°F, 105°F, 110°F, 115°F, 120°F, 125°F, 130°F, 140°F, 150°F, 160°F, 170°F, 175°F, 180°F, 190°F, 200°F, AND 210°F.
 - NOTE: CLOSING TEMPERATURE IS TYPICALLY 10°F BELOW OPENING TEMPERATURE FOR REVERSE ACTING VALVES.
- BAND-O-LET FITTING OPTIONAL (HOSE CLAMP NOT INCLUDED), FOR SENSING PIPE OD TEMPERATURES.
- BUNA IS STANDARD; VITON, EPDM, AND KALREZ ARE AVAILABLE. CONSULT OUR ENGINEERS FOR ORDERING INFORMATION.
- A #20 MESH STRAINER IS RECOMMENDED.

A

A

COMPONENT	SURFACE SENSING TEMPERATURE CONTROL VALVE
-----------	---



ThermOmegaTech, Inc.
353 Ivyland Road
Warminster, PA 18974-2205, USA
Ph: 215-798-5978

This file and any associated information and specifications are provided for reference and evaluation purposes only, and is subject to change without notice. ThermOmegaTech makes no representations, warranties or guarantees as to the appropriateness, accuracy, completeness, or suitability for any purpose, of the file, information or specifications. You are solely responsible for the use of the file, information or specifications.

This drawing is the property of ThermOmegaTech. It contains confidential, proprietary information that is ThermOmegaTech property. Do not disclose to or duplicate for others except as authorized by ThermOmegaTech.

SCALE

NTS

655-000000-XXX

3/4" US/S-X-S

UNIT

INCH [MM]

SHEET

1 of 1

4

3

2

1