

4

3

2

1

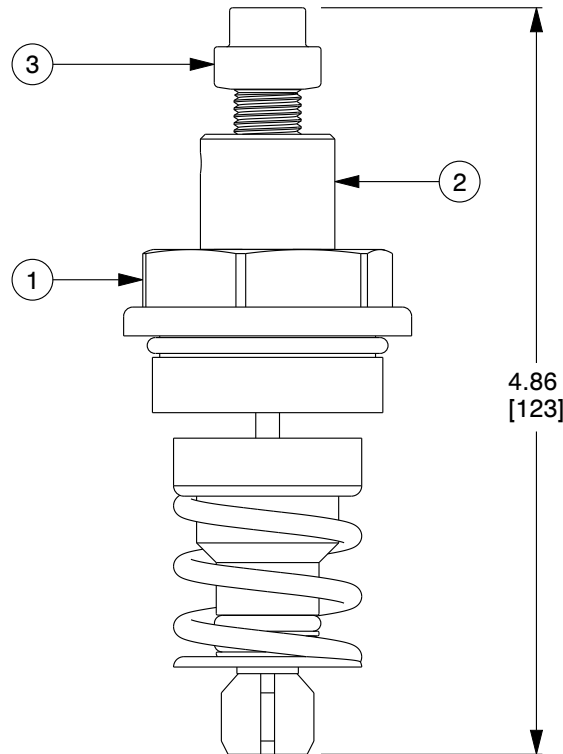
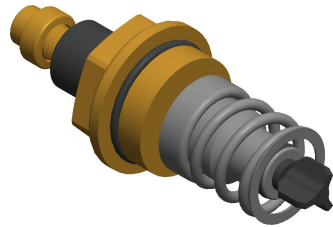

ITEM	DESCRIPTION	MATERIAL
1	VALVE CAP	Brass
2	INSULATOR BUSHING	Acetal Plastic
3	THERMAL ACTUATOR	Brass

B

B

A

A

NOTES:

1. MAXIMUM OPERATING PRESSURE: 60 PSIG (4.1 BAR).
2. EASY INSTALLATION, SHOCK AND VIBRATION TESTED.
3. ELIMINATES COSTLY FREEZE DAMAGE IN PASSENGER CARS.
4. COMPLIES WITH FIRE SAFETY REQUIREMENTS UNDER TITLE 49, CHAPTER II, PART 238.103.
5. NSF 61/372 CERTIFIED.

COMPONENT	PASSENGER CAR POTABLE WATER SYSTEM FREEZE PROTECTION
-----------	--



ThermOmegaTech, Inc.
353 Ivyland Road
Warminster, PA 18974-2205, USA
Ph: 215-798-5978

This file and any associated information and specifications are provided for reference and evaluation purposes only, and is subject to change without notice. ThermOmegaTech makes no representations, warranties or guarantees as to the appropriateness, accuracy, completeness, or suitability for any purpose, of the file, information or specifications. You are solely responsible for the use of the file, information or specifications.

This drawing is the property of ThermOmegaTech. It contains confidential, proprietary information that is ThermOmegaTech property. Do not disclose to or duplicate for others except as authorized by ThermOmegaTech.

SCALE

NTS

450-010000-035

3/4" GURU PC - CARTRIDGE ASSEMBLY

UNIT

INCH [MM]

SHEET

1 of 1

4

3

2

1